



anovafurnishings.com
888.535.5005 tel

ASSEMBLY INSTRUCTIONS

Picnic Tables with Pedestal Inground Mount

D1005 – 46” Round Table

D1080 – 46” Square Table

D1081 – 46” Square ADA Table

D1135 – 46” Square ADA Table

D1193 – 46” Round ADA Table

F1005 – 46” Round Table

F1074 – 46” Octagonal Table

F1078 – 46” Square Table

F1080 – 46” Square Table

F1081 – 46” Square ADA Table

F1135 – 46” Square ADA Table

F1193 – 46” Round ADA Table

R1111I – 46” Square Table

R1111S – 46” Square Table



Model D1005 shown.
Tabletop shape and pattern may vary.
Seat shape and pattern may vary.

TOOLS NEEDED:

- Ratchet with 1/2” Socket
- Ratchet with 3/4” Socket
- 1/2” Open-end or Box-end Wrench
- 3/4” Open-end or Box-end Wrench
- Level

ASSEMBLY HARDWARE:

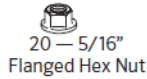
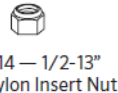
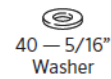
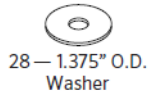
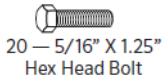
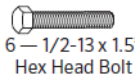
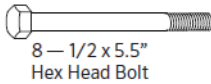

BENCH COMPONENTS:

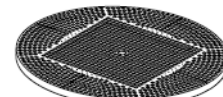
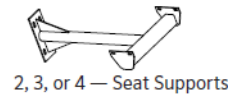
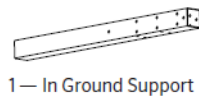

ASSEMBLY:

The assembly is a two-person operation.

1. Inspect the shipping container contents for damage and to determine that all components and hardware are present.

2. Locate the Inground Support and the Tabletop Adapter and lay them out on the packing cardboard or other soft surfaced workspace.

3. Align the mounting holes in the Tabletop Adapter with the holes in the appropriate end of the Inground Support. Install one of the 1.375” O.D. Washers onto one of the 1/2” x 1.5” Long Bolts and insert the Bolt through both parts, with the Bolt head on the outside surface of the Inground Support. Install a 1.375” O.D. Washer and 1/2” Nylon Insert Nut on the inside end of the Bolt.

Use the Ratchet with 3/4” Socket and 3/4” Wrench to tighten the Nuts.

Repeat this for the other two mounting holes on the top side of the Adapter/Support assembly.

Turn the assembly over and repeat for the three mounting holes on the other side of the assembly.

4. Determine the location for Table.

IMPORTANT: Locate underground utilities and avoid them while digging the hole for the concrete base.

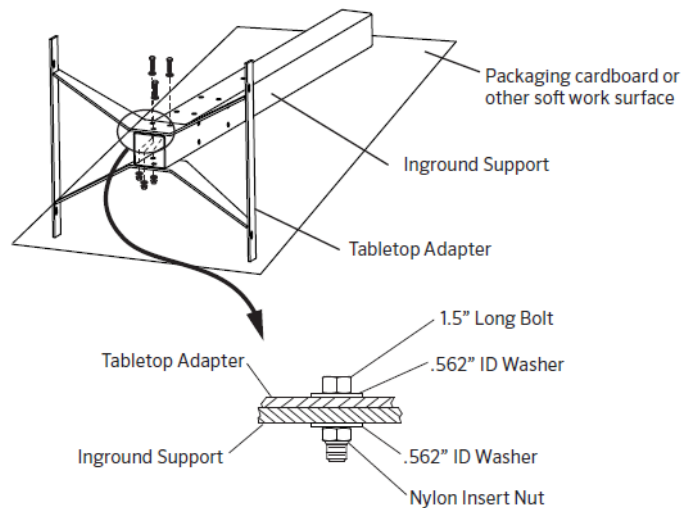

- The walls of the concrete base should be vertical and smooth to minimize the effects of frost upheaval. This can be achieved with the use of concrete forms, such as Sonotube. Consider extending the concrete base below the frost line. Consult a professional for loose or unusual soil conditions.
- Create a temporary structure that will be used to support the Adapter/Support Assembly, at the desired height and level, while the concrete is curing. The depth to install the Inground Support is dependant on the application: 26.06" depth for non-ADA installations and tables with 4 seats; 22.94" depth for ADA compliance (for tables with less than 4 seats) to achieve the required table clearance.
- Fill forms with concrete and insert supports, centered in concrete, until the Adapter/Support Assembly is supported by the temporary structure. Allow the interior of the Inground Support to fill with concrete up to the Drain Hole. Crown the concrete cap to optimize drainage. Allow the concrete to cure before attaching the Seat Support assemblies.

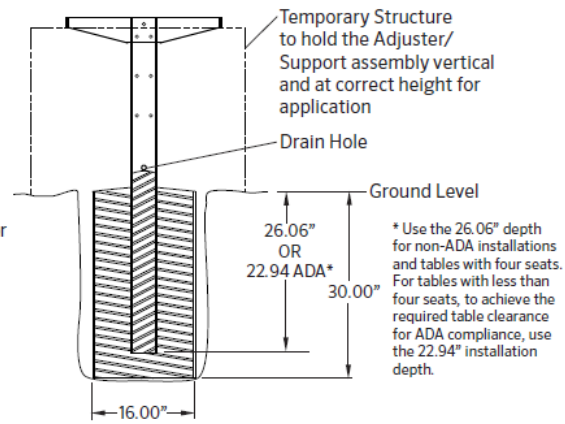

- Place one of the seats upside down on the packing cardboard or other soft work surface. Position one of the Seat Supports so the mounting holes in the Seat Support line up with the mounting holes on the Seat Frame.
Place one of the 5/16" Washers on one of the 1.25" long Bolts and insert the Bolt through the Seat Support and Seat Frame mounting holes. Apply a 5/16" Washer and 5/16" Nut to the end of the Bolt and tighten finger tight. Repeat for the other three mounting holes. After all Bolts are installed, use the Ratchet with 1/2" Socket and 1/2" wrench to tighten the Nuts.
Attach the remaining Seats to the remaining Seat Supports in the same manner. Tables may have 2, 3, or 4 seats depending on the model.

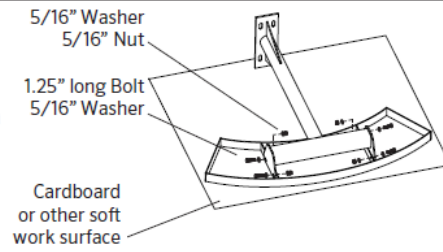

- After the concrete has cured and the installation hole is backfilled, position two of the Seat Support assemblies on opposite sides of the Inground Support. Place a 1.375" O.D. Washer onto one of the 5.5" Long Bolts and insert the Bolt through the mounting holes of the Inground Support and both Seat Supports. Add a 1.375" O.D. Washer and Nylon Insert Nut to the end of the Bolt and tighten the Nut finger tight.
Repeat for the other three mounting holes in the Seat Support assemblies. After all bolts are installed, use the Ratchet with 3/4" Socket and 3/4" Wrench to tighten the Nuts. Check with a Level and adjust the seat as needed while tightening. Install any remaining Seat Support assemblies in the same manner.

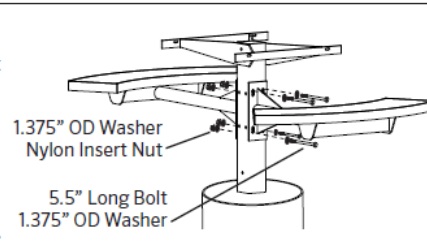

- Position the Table top on the Table top Adapter so that the mounting holes in the Frame of the Table top align with the mounting holes in the Table top Adapter. Place one of the 5/16" Washers on one of the 1.25" Long Bolts and insert the Bolt through the Table top Frame and the Table top Adapter mounting holes. Apply a 5/16" Washer and 5/16" Nut to the end of the Bolt and tighten finger tight.
Repeat for the other three mounting holes in the Table top and the Table top Adapter. After all Bolts are installed, use the Ratchet with 1/2" Socket and 1/2" Wrench to tighten the Nuts. Use a Level while tightening the hardware and adjust the Table top as needed while tightening.

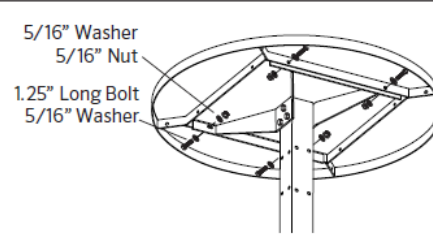

 WARNING	<ul style="list-style-type: none"> Furniture must not be used other than for its intended purpose and should be inspected regularly for loose, missing, or broken hardware, and general instability. Furniture that is damaged or appears to be unstable must be removed from service and be repaired or replaced. Repairs must be made using only factory authorized parts and methods.
--------------------	---

CARE AND MAINTENANCE	<ul style="list-style-type: none"> Do not drag the assembled unit across any surface. This product requires only periodic cleaning with a sponge and a solution of mild detergent and water to remove surface dirt. Do not clean with a solvent or petroleum based products.
-----------------------------	--