

TRL 32"

SKU: TRL32

NOTES

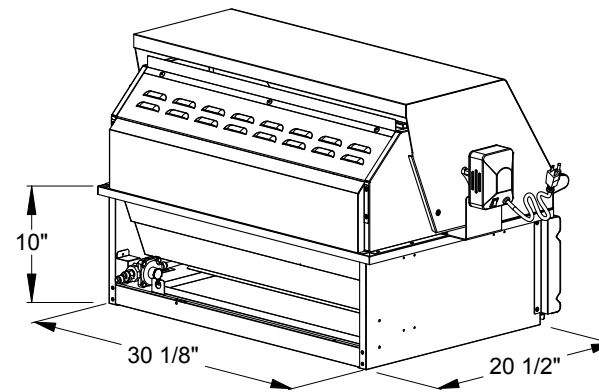
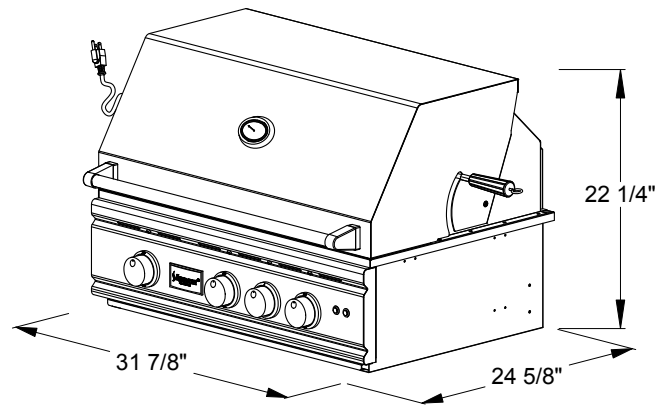

DISCLAIMER

We recommend adding a 1/4" (.25) to the inner dimension to ensure the unit fits properly in the build out.